

取付参考図 type A

目地15mmタイプ / 正面より取付 M4ビス止め

素材: アルミニウム5052 (t=2mm)
 Color: 全艶白(N-95) ポリエステル樹脂系粉体焼付塗装
 ※特色、特注サイズをご希望の方はP30参照

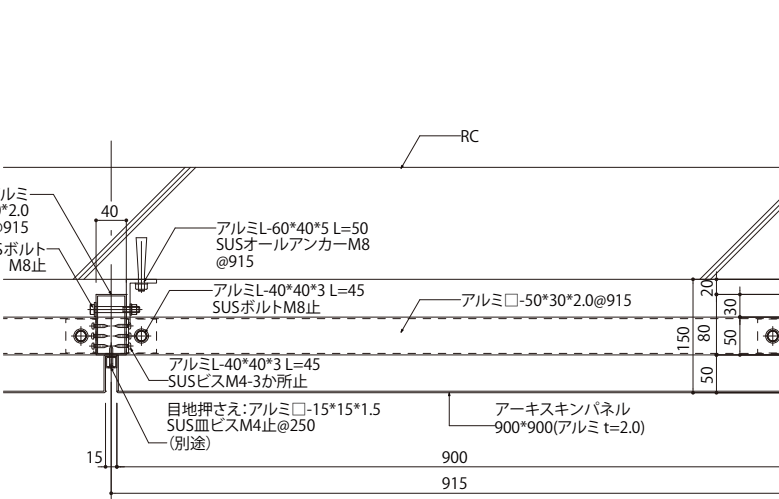
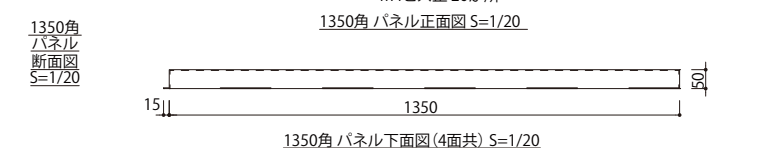
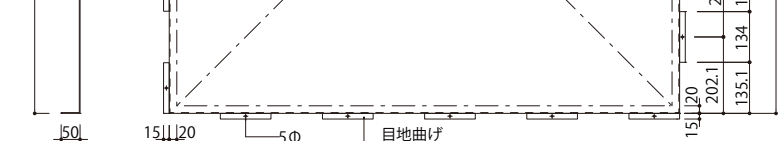
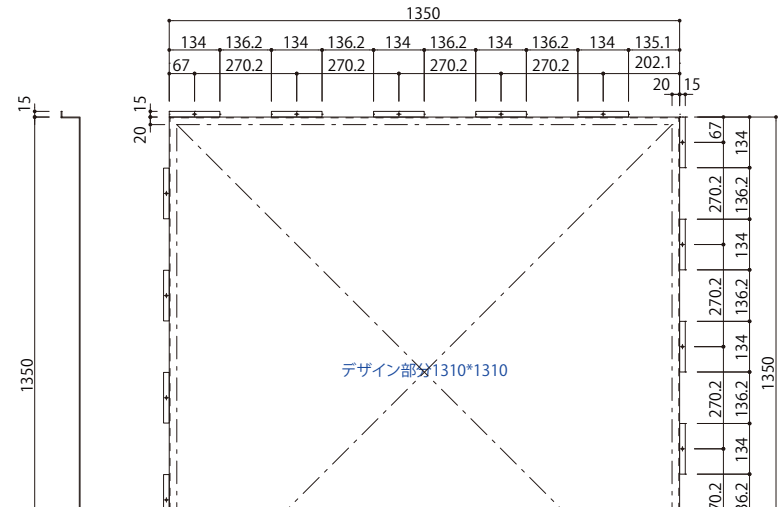
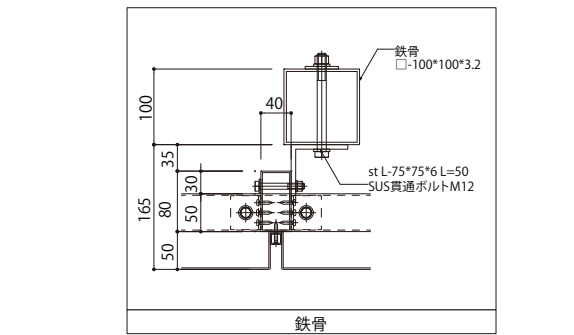
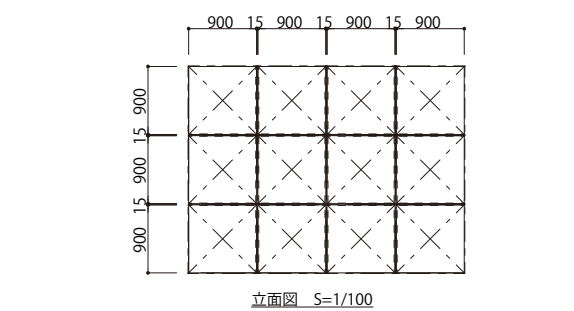
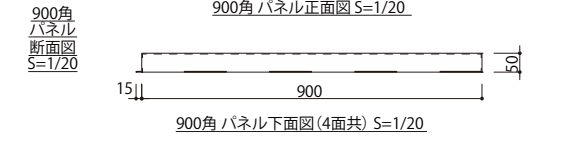
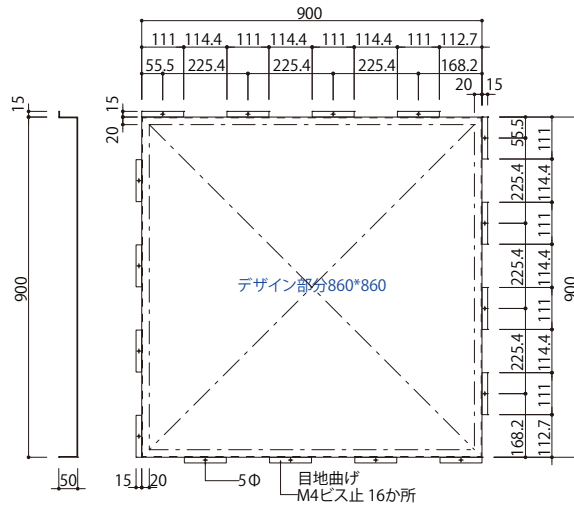

平断面詳細図 (RC) S=1/10

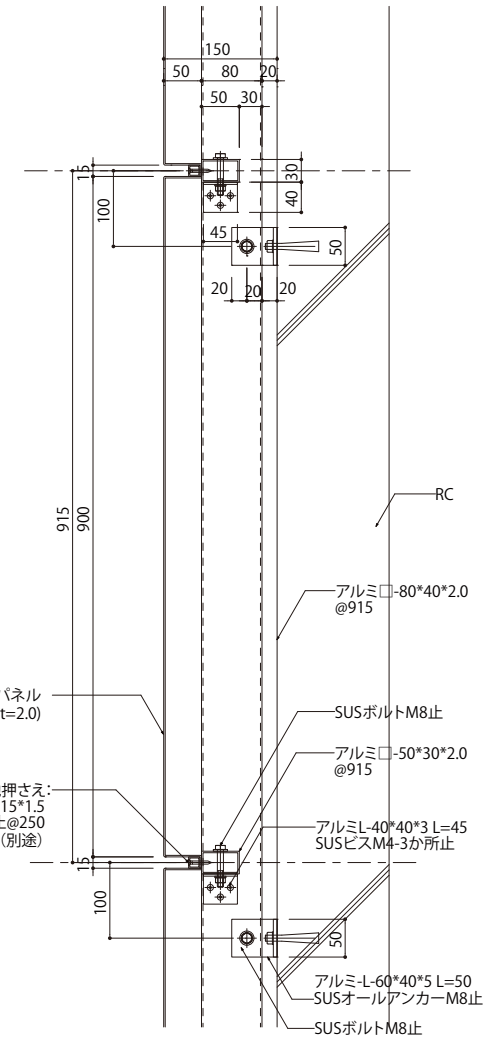

立断面詳細図 (RC) S=1/10